



User Manual (EN)

©2021 Hangzhou Hikvision Digital Technology Co., Ltd. All rights reserved.

About this Manual

The Manual includes instructions for using and managing the Product. Pictures, charts, images and all other information hereinafter are for description and explanation only. The information contained in the Manual is subject to change, without notice, due to firmware updates or other reasons. Please find the latest version of this Manual at the Hikvision website (<https://www.hikvision.com/>). Please use this Manual with the guidance and assistance of professionals trained in supporting the Product.

Trademarks

● **HIKVISION** and other Hikvision's trademarks and logos are the properties of Hikvision in various jurisdictions.

Other trademarks and logos mentioned are the properties of their respective owners.

● Other trademarks and logos mentioned are the properties of their respective owners.

● **HDMI** : The terms HDMI and HDMI High-Definition Multimedia Interface, and the HDMI Logo are trademarks or registered trademarks of HDMI Licensing Administrator, Inc. in the United States and other countries.

Disclaimer

TO THE MAXIMUM EXTENT PERMITTED BY APPLICABLE LAW, THIS MANUAL AND THE PRODUCT DESCRIBED, WITH ITS HARDWARE, SOFTWARE AND FIRMWARE, ARE PROVIDED "AS IS" AND "WITH ALL FAULTS AND ERRORS". HIKVISION MAKES NO WARRANTIES, EXPRESS OR IMPLIED, INCLUDING WITHOUT LIMITATION, MERCHANTABILITY, SATISFACTORY QUALITY, OR FITNESS FOR A PARTICULAR PURPOSE. THE USE OF THE PRODUCT BY YOU IS AT YOUR OWN RISK. IN NO EVENT WILL HIKVISION BE LIABLE TO YOU FOR ANY SPECIAL, CONSEQUENTIAL, INCIDENTAL, OR INDIRECT DAMAGES, INCLUDING, AMONG OTHERS, DAMAGES FOR LOSS OF BUSINESS PROFITS, BUSINESS INTERRUPTION, OR LOSS OF DATA, CORRUPTION OF SYSTEMS, OR LOSS OF DOCUMENTATION, WHETHER BASED ON BREACH OF CONTRACT, TORT (INCLUDING NEGLIGENCE), PRODUCT LIABILITY, OR OTHERWISE, IN CONNECTION WITH THE USE OF THE PRODUCT, EVEN IF HIKVISION HAS BEEN ADVISED OF THE POSSIBILITY OF SUCH DAMAGES OR LOSS.

YOU ACKNOWLEDGE THAT THE NATURE OF THE INTERNET PROVIDES FOR INHERENT SECURITY RISKS, AND HIKVISION SHALL NOT TAKE ANY RESPONSIBILITIES FOR ABNORMAL OPERATION, PRIVACY LEAKAGE OR OTHER DAMAGES RESULTING FROM CYBER-ATTACK, HACKER ATTACK, VIRUS INFECTION, OR OTHER INTERNET SECURITY RISKS; HOWEVER, HIKVISION WILL PROVIDE TIMELY TECHNICAL SUPPORT IF REQUIRED.

YOU AGREE TO USE THIS PRODUCT IN COMPLIANCE WITH ALL APPLICABLE LAWS, AND YOU ARE SOLELY RESPONSIBLE FOR ENSURING THAT YOUR USE CONFORMS TO THE APPLICABLE LAW. ESPECIALLY, YOU ARE RESPONSIBLE, FOR USING THIS PRODUCT IN A MANNER THAT DOES NOT INFRINGE ON THE RIGHTS OF THIRD PARTIES, INCLUDING WITHOUT LIMITATION, RIGHTS OF PUBLICITY, INTELLECTUAL PROPERTY RIGHTS, OR DATA PROTECTION AND OTHER PRIVACY RIGHTS. YOU SHALL NOT USE THIS PRODUCT FOR ANY PROHIBITED END-USES, INCLUDING THE DEVELOPMENT OR PRODUCTION OF WEAPONS OF MASS DESTRUCTION, THE DEVELOPMENT OR PRODUCTION OF CHEMICAL OR BIOLOGICAL WEAPONS, ANY ACTIVITIES IN THE CONTEXT RELATED TO ANY NUCLEAR EXPLOSIVE OR UNSAFE NUCLEAR FUEL-CYCLE, OR IN SUPPORT OF HUMAN RIGHTS ABUSES.

IN THE EVENT OF ANY CONFLICTS BETWEEN THIS MANUAL AND THE APPLICABLE LAW, THE LATTER PREVAILS.

Regulatory Information

FCC Information

Please take attention that changes or modification not expressly approved by the party responsible for compliance could void the user's authority to operate the equipment.

FCC Compliance

This equipment has been tested and found to comply with the limits for a Class A digital device, pursuant to part 15 of the FCC Rules. These limits are designed to provide reasonable protection against harmful interference when the equipment is operated in a commercial environment. This equipment generates, uses, and can radiate radio frequency energy and, if not installed and used in accordance with the instruction manual, may cause harmful interference to radio communications. Operation of this equipment in a residential area is likely to cause harmful interference in which case the user will be required to correct the interference at his own expense.

FCC Conditions

This device complies with part 15 of the FCC Rules. Operation is subject to the following two conditions:

1. This device may not cause harmful interference.
2. This device must accept any interference received, including interference that may cause undesired operation.

EU Conformity Statement

 This product and - if applicable - the supplied accessories too are marked with "CE" and comply therefore with the applicable harmonized European standards listed under the EMC Directive 2014/30/EU, the LVD Directive 2014/35/EU, the RoHS Directive 2011/65/EU.



2012/19/EU (WEEE directive): Products marked with this symbol cannot be disposed of as unsorted municipal waste in the European Union. For proper recycling, return this product to your local supplier upon the purchase of equivalent new equipment, or dispose of it at designated collection points. For more information see: www.recyclethis.info



2006/66/EC (battery directive): This product contains a battery that cannot be disposed of as unsorted municipal waste in the European Union. See the product documentation for specific battery information. The battery is marked with this symbol, which may include lettering to indicate cadmium (Cd), lead (Pb), or mercury (Hg). For proper recycling, return the battery to your supplier or to a designated collection point. For more information see: www.recyclethis.info

Industry Canada ICES-003 Compliance

This device meets the CAN ICES-003 (A)/NMB-003(A) standards requirements.



Applicable Models

This manual is applicable to the models listed in the following table.

Series	Model
DS-D60XXX	DS-D6065UN
	DS-D6075UN
	DS-D6086UN

Symbol Conventions

The symbols that may be found in this document are defined as follows.

Symbol	Description
 Note	Provides additional information to emphasize or supplement important points of the main text.
 Caution	Indicates a potentially hazardous situation, which if not avoided, could result in equipment damage, data loss, performance degradation, or unexpected results.
 Danger	Indicates a hazard with a high level of risk, which if not avoided, will result in death or serious injury.

Safety Instructions

- Proper configuration of all passwords and other security settings is the responsibility of the installer and/or end-user.
- In the use of the product, you must be in strict compliance with the electrical safety regulations of the nation and region. Please refer to technical specifications for detailed information.
- Input voltage should meet both the SELV (Safety Extra Low Voltage) and the Limited Power Source with 100 to 240 VAC or 12 VDC according to the IEC60950-1 standard. Please refer to technical specifications for detailed information.
- Do not connect several devices to one power adapter as adapter overload may cause over-heating or a fire hazard.
- Please make sure that the plug is firmly connected to the power socket.
- If smoke, odor or noise rise from the device, turn off the power at once and unplug the power cable, and then please contact the service center.

WARNING: This equipment is compliant with Class A of EN55032/CISPR 32. In a residential environment this equipment may cause radio interference.

TABLE OF CONTENTS

1. Safety Instructions	5
1.1 Screen Maintenance	8
2. Operation Instructions	9
2.1 Control Panel.....	9
2.1.1 Back Controller.....	9
2.1.2 Front.....	10
2.1.3 Back	10
2.2 Remote Control	12
2.3 Inserting the batteries in the remote control	13
3. Installation Instructions.....	14
3.1 Connecting External Equipment.....	14
3.2 How to adjust the settings	16
3.3 OSD Menu Operation.....	17
4. Troubleshooting.....	21
5. Technical Specifications	24
5.1 Display:.....	24
5.2 Input Mode	27

1. Safety Instructions

Pixel feature

This liquid crystal display product has ultrahigh color resolution. While its effective pixels are up to 99.999% or higher, it is still possible that a dark spot or a bright spot (red, green or blue) constantly appears on the screen. This is the structure property (within the general industrial standard) of the display rather than a fault.

Safety

Please read and understand all instructions before using the monitor safety . Damage resulting from nonobservance of the instructions is not covered by the warranty.

Be careful of electric shock and fire!

- Never make the monitor contact with rain or water. Never place a liquid container (e.g., a vase) near or on the monitor. Please disconnect the monitor's power immediately if a liquid is spilled on the monitor's surface or inside. Please contact the customer service center before using it again.
- Never put a monitor, remote controller, or battery near an open flame or other heat source (including direct sunlight). In order to avoid flame spread, always keep candles or other open flames away from monitors, remote controls, and batteries.



- Never insert any object into the ventilation slot or other openings on the monitor.
- Please make sure that the power line is not taut. The tightening of the power line will loose the power connections and produce sparks.

Beware of short circuit or fire!

- Do not expose the remote controller or battery in rain, water or overheated environment.
- Please avoid pulling the plug. Loose power plugs may spark or cause fire.

Watch out for personal injury or monitor damage!

- It is suggested that the monitor be carried by two people.
- When installing the monitor on the stand, please use only the chassis provided. Firmly fix the frame on the monitor. Put the monitor on a flat, flat surface that can withstand the total weight of the monitor and the chassis.
- When installing a monitor with wall mounting, please use only the wall mount bracket that can bear the weight of the monitor. Fix the wall mount mounting bracket on the wall that can withstand the total weight of the monitor and the wall mount bracket.
The company is not responsible for the accident, personal injury or loss caused by improper installation.

Be careful of hurting children!

Please follow the following precautions to avoid child injury due to monitor falling:

- Never place the monitor on a surface covered with a cloth or other material that can be pulled.
- Make sure that any part of the monitor is within the edge of the surface.
- When placing a monitor on a high furniture (such as a bookcase), the furniture and monitor must be fixed to the wall or the appropriate support.
- Tell children about the dangers of climbing furniture and touching monitors.

Beware of eating battery!

- The remote control of this product contains batteries. There is a risk that children might eat the batteries. Please keep them out of reach of children.

Watch out for overheating!

- Never install the monitor in the enclosed space. Always leave at least 4 inches or 10 centimeters of space around the monitor for ventilation. Make sure that curtains or other objects do not block the ventilation slot on the monitor.

Be careful! Don't break the monitor!

- Before you connect the monitor to the power outlet, make sure that the power voltage matches the value printed on the back of the monitor. If the voltage is different, don't connect the monitor to the power outlet.
- If the monitor is not used for a long time, please cut off the power supply.

Be careful of personal injury, fire or power line damage!

- Do not put the monitor or any object on the power line.
- As a disconnecting device, the power plug should be kept to operate conveniently.

- When the power line is disconnected, always hold the plug instead of pulling the cable.
- Before the thunderstorm comes, disconnect the monitor from the power outlet and the antenna. Never touch any part of a monitor, a power line, or an antenna in a thunderstorm.
- The wired network antenna connected to the equipment must be isolated from the protective grounding, otherwise it may cause fire and other dangers!

Watch out for hearing impairment!

- Avoid using headphones or earphones at high volume or for a long time.

Low temperature

- If the monitor is transported below 5°C, please open the package of the monitor. Wait for the monitor to adapt to the room temperature, and then connect the monitor to the power outlet.
- If provided with a 3-pin attachment plug on the power cord, plug the cord into a grounded (earthed) 3-pin outlet. Do not disable the power cord grounding pin, for example, by attaching a 2-pin adapter. The grounding pin is an important safety feature.

1.1 Screen Maintenance

Before using the monitor, please read and understand all the instructions. Damage resulting from nonobservance of the instructions is not covered by the warranty.

- Try to avoid still images. A still image means that an image stays on the screen for a long time. Still image may cause permanent damage to the monitor screen;
- the monitor screen to cause image blur, afterimage, local traces, and the display is not within the scope of warranty
- Don't display static images for more than 2 hours on the LCD monitor, because it will cause the screen image blur. In order to avoid this problem please reduce the brightness and contrast of the screen in the display of a still image.
- When you watch 4:3 programs for a long time, you leave different marks on the left and right sides of the screen and the edges of the image, so please don't use this mode for a long time.
- Image sticking may occur if playing video games or displaying still images for a long time. It is caused by screen burn. Please reduce brightness and contrast when appropriate.
- Pull out the monitor plug before cleaning.
- Use a soft dry cloth to wipe the monitor and frame. Do not use alcohol, chemicals or household cleaning agent cleaning monitor.
- Watch out for damage to monitor screen! Do not use any object to contact, push, rub or tap the screen.
- In order to avoid deformation and fading, please wipe water as soon as possible.

2. Operation Instructions

2.1 Control Panel

2.1.1 Back Controller

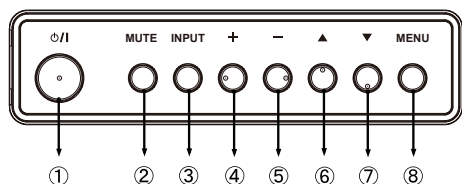

①		Power Button
②	MUTE	Mute Button
③	INPUT	Input Select Button
④	+	+ Button
⑤	-	- Button
⑥	▲	Up Button
⑦	▼	Down Button
⑧	MENU	Menu Button

2.1.2 Front

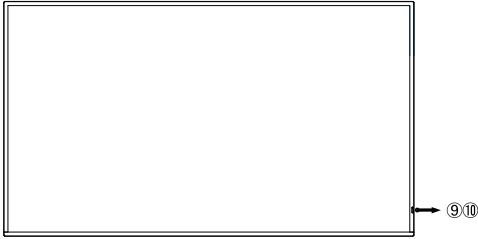

⑨	Power Indicator	Green	Lighting : Normal Operation Flash : When SCHEDULE is enabled
		Red	If turn off the Power Button on the Remote Control and the Back Controller. Standby Mode
		Off	Power Off
⑩	Remote Sensor		Remote Sensor

2.1.3 Back

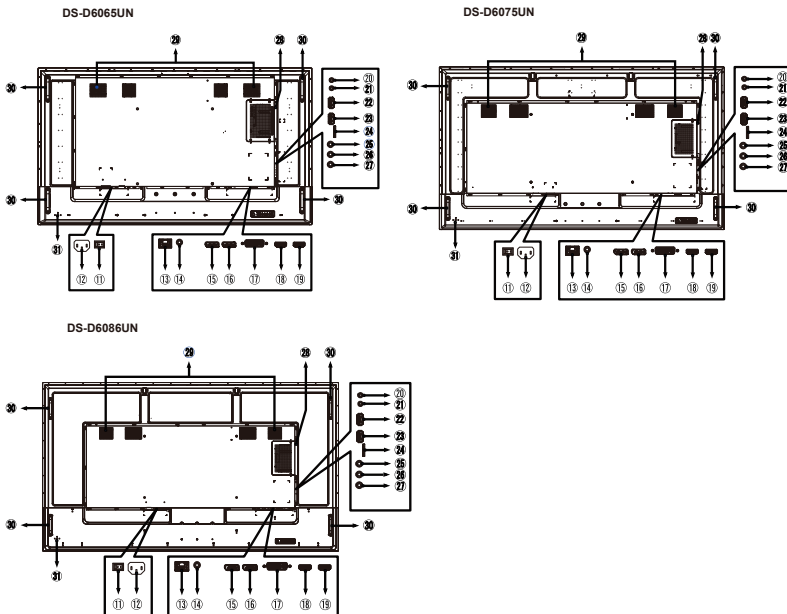

⑪	AC SWITCH I(ON) / O(OFF)	MAIN POWER	Main Power Switch,
⑫	AC IN	AC-INLET	AC Connector(∼: Alternating current)
⑬	LAN	RJ45	RJ45 Connector
⑭	AUDIO OUT	Mini Jack	Audio Connector,
⑮	DisplayPort IN	DisplayPort	DisplayPort Connector
⑯	DisplayPort OUT	DisplayPort	DisplayPort Connector
⑰	DVI IN	DVI-I	DVI-I Connector
⑱	HDMI1 IN	HDMI	HDMI Connector
⑲	HDMI2 IN	HDMI	HDMI Connector
⑳	RS232 OUT	Mini Jack	RS232 Connector
㉑	RS232 IN	Mini Jack	RS232 Connector
㉒	USB2	USB2.0 (5V, 500mA)	USB Connector
㉓	USB1	USB2.0 (5V, 500mA)	USB Connector
㉔	MICRO SD		Micro SD slot
㉕	IR OUT	IR	IR Connector
㉖	IR IN	IR	IR Connector
㉗	AUDIO IN	Mini Jack	Audio Connector
㉘	Option Slot (SDM-L)		Option Slot
㉙	Speakers		Speakers
㉚	Handles		Handles, Handgriffe, Poignées, Handvatten, Uchwyty, Рукоятки, Madla, Handles
㉛	Keyhole for Security Lock		Keyhole for Security Lock,

2.2 Remote Control

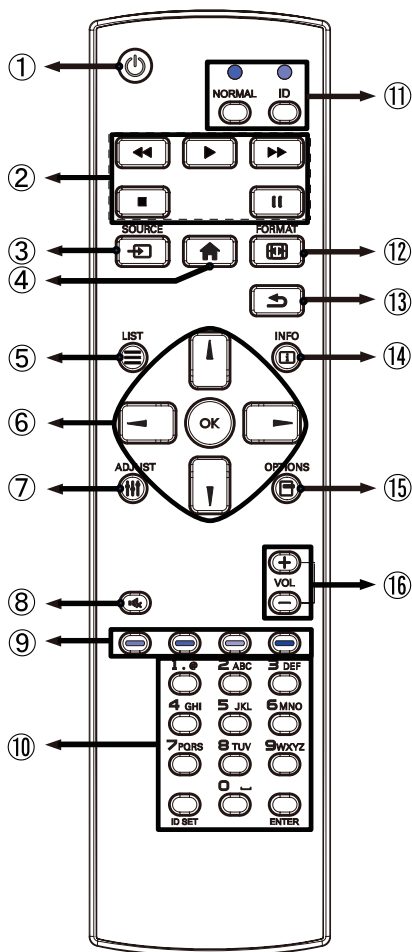

1. Turns the display ON and OFF.
2. [PLAY] Control playback of media files.
 - : Play
 - : Stop
 - : Pause
 - : Quick-Return

- : Fast-Forward
- 3. SOURCE Selects the source. Press or button to select from HDMI1, HDMI2, DVI-I, DisplayPort, AndroidOS. Press [OK] button to confirm and exit.
- 4. HOME Go back to AndroidOS home.
- 5. LIST Press the menu.
- 6. Mute Navigates through submenus and settings.
 - : Up Button
 - : Down Button
 - : Left Button
 - : Right Button
- OK: Confirms your selection or save changes.
- 7. ADJUST Not available on this model.
- 8. MUTE Turns on or off the mute function when the Menu is not displayed.
- 9. COLOR Not available on this model.
- 10. NUMBER/ID SET/ENTER Enter text for network setting.
- 11. ID Mode ID: To enter ID Mode
NORMAL: To leave ID Mode
- 12. FORMAT Change picture format.
- 13. BACK Returns to a previous menu or

closes the OSD Menu.

14. **i** INFO

Provides source and resolution information.

15. **☰** OPTIONS

Not available on this model.

16. VOLUME - / +

VOLUME-: Decreases the sound volume.

VOLUME+: Increases the sound volume.

2.3 Inserting the batteries in the remote control

To use the remote control, insert the two dry batteries. Legen sie die zwei Batterien ein um die Fernbedienung zu benutzen.

1. Press and then slide the battery cover to open it.

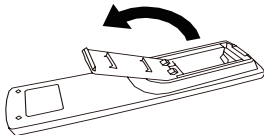

2. Align and insert two AAA batteries according to their plus and minus ports (as indicated in the remote control).

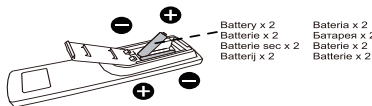

3. Replace the battery cover.

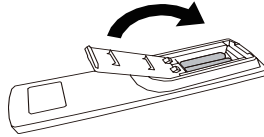

Note:

- Refer to the above instructions when taking out the batteries.
- Replace with new batteries when the Remote Control does not work close to the monitor. Use AAA dry batteries. Risk of explosion if battery is replaced by an incorrect type.
- Operate the Remote Control by pointing it toward the Remote Sensor on the monitor.
- Other manufacturers remote control will not work with this monitor. Use the provided Remote Control ONLY.
- Used batteries needed to follow the city rule to be discarded. (suggestion: to dispose of used batteries please follow correct policy as per your council regulations)
- Batteries shall not be exposed to excessive heat such as sunshine, fire or the like.
- If you do not intend to use the remote control for a long period, remove the batteries.

3. Installation Instructions

⚠ Note: The following illustration for the rear case of the monitor connecting to an external device is for reference only. Actual products may vary.

3.1 Connecting External Equipment

Connection example with the peripheral device

DS-D6065UN

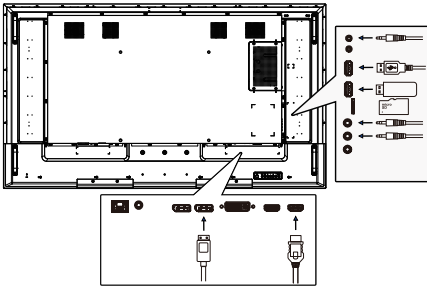

DS-D6075UN

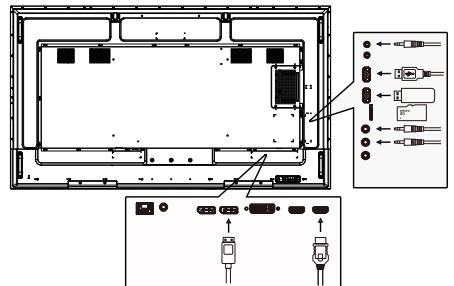



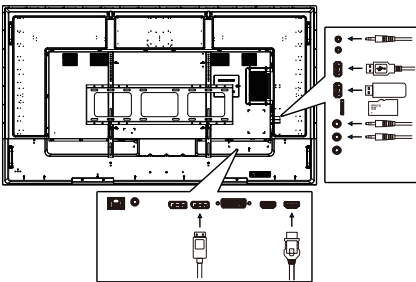



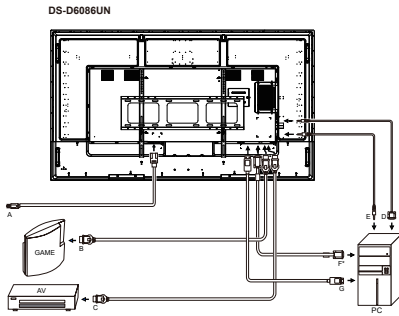
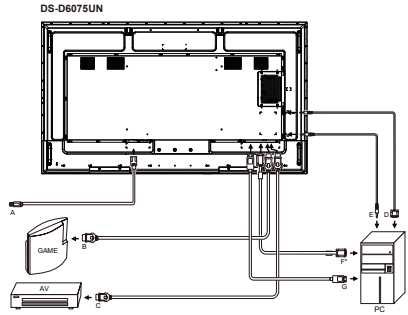
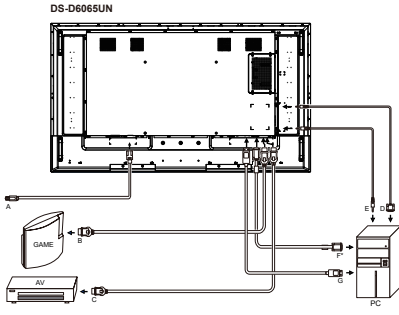

DS-D6086UN



Example of Connection



3.2 How to adjust the settings

1. Press the button “” to display the OSD options.
2. Press “” or “” to browse the menu items.
After reversing out the required item, press the button “” to enter.
3. Press “” or “” again to browse the sub-menu.
After reversing out the required item, press the button “” to make adjustments.
4. Press the button “” to save the adjustments and to exit. To adjust other settings, please repeat steps 2-4.

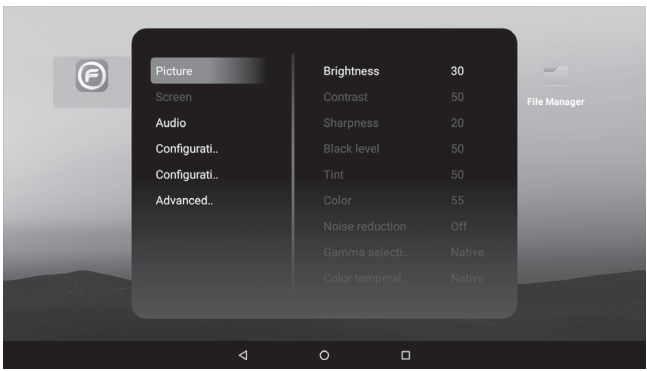

3.3 OSD Menu Operation

Column 1	Column 2	Column 3
Picture	Brightness	0~100[1]
	Contrast	0~100[1]
	Sharpness	0~100[10]
	Black level	0~100[1]
	Tint	0~100[1]
	Color	0~100[1]
	Noise reduction	Off/Low/Medium/High
	Gamma selection	Native/2.2/2.4/S gamma/D-image
	Color temperature	3000K/4000K/5000K/6500K/7500K/ 9300K/10000K/Native/ User 1 / User 2
	Color control	User-R (0-255)[1]
		User-G (0-255)[1]
		User-B (0-255)[1]
		2000K - 10000K
	Smart power	Off/Medium/High
Overscan	Off/On	
Picture reset	Cancel/Reset	
Screen	Zoom mode	Full/4:3/Real/21:9/Custom
	Screen reset	CANCEL/RESET

Audio	Balance	0~100[1]
	Treble	0~100[1]
	Bass	0~100[1]
	Volume	0~100[1]
	Maximum volume	0~100[1]
	Minimum volume	0~100[1]
	Mute	Mute Off/On
	Audio source	Analog/Digital
	Audio reset	CANCEL/RESET
Configuration1	Switch on state	Power off/Forced on/Last status
	Panel saving	Brightness: Off/On
		Pixel Shift: Off/Auto/10~900 Seconds
	RS232 routing	RS232(default)/LAN->RS232
	WOL	Off/On
	Configuration1 reset	CANCEL/RESET
Factory reset	CANCEL/RESET	
Configuration2	OSD turn off	Off,5~120[5] seconds
	OSD H position	0~100[1]
	OSD V position	0~100[1]
	System rotation	Landscape/Portrait
	Information OSD	Off,1-60[1] Sec.
	Logo	Off/On/User
	Monitor ID	Monitor ID: 1~255[1]
		Monitor group: 1-254[1]
	Heat status	xx °C xx °F
		Sensor 2 xx °C xx °F
	Monitor information	Model name
		Serial No
		Operation hours
SW Version		
DP version	1.1 / 1.2SST / 1.2MST	
HDMI Version	1.4 / 2.0	
Configuration2 reset	CANCEL/RESET	

Advanced Option	IR control	Unlock
		Lock All
		Lock All but Volume
		Lock All but Power
		Lock all except PWR & VOL
		Primary
		Secondary
	Power LED light	On/Off[On]
	Keyboard control	Unlock
		Lock All
		Lock All but Volume
		Lock All but Power
		Lock all except PWR & VOL
	Off Timer	Off/1Hour~24[1] Hours
	HDMI with One Wire	Off(default)/On
	HDMI with One Wire Power off	Off(default)/On

Advanced Option	Language	English/Español/Français/Italiano/ Latviešu/Lietuvių/Nederlands/ Norsk bokmål/Polski/Português/ Suomi/Svenska/Türkçe/Русский / اڻي پيرعلا / 简体中文 / 繁體中文 / 日本 語 / Čeština/Dansk/Deutsch/Eesti
	OSD transparency	Off/5-100[5]
	Power Save	Mode 1 [TCP off, WOL on, auto off] (default), Mode 2 [TCP off, WOL on, auto on/ off] Mode 3 [TCP on, WOL off, auto on/ off] Mode 4 [TCP on, WOL off, no auto on/off]
	Advanced option reset	Cancel/Reset

4. Troubleshooting

Symptom	Possible Cause	Remedy
No picture is displayed	<ol style="list-style-type: none"> 1. The power cord is disconnected. 2. The main power switch on the back of the display is not switched on. 3. The selected input has no connection. 4. The display is in standby mode. 	<ol style="list-style-type: none"> 1. Plug in the power cord. 2. Make sure the power switch is switched on. 3. Connect a signal connection to the display.
Interference displayed on the display or audible noise is heard	Caused by surrounding electrical appliances or fluorescent lights.	Move the display to another location to see if the interference is reduced.
Color is abnormal	The signal cable is not connected properly.	Make sure that the signal cable is attached firmly to the back of the display.
Picture is distorted with abnormal patterns	<ol style="list-style-type: none"> 1. The signal cable is not connected properly. 2. The input signal is beyond the capabilities of the display. 	<ol style="list-style-type: none"> 1. Make sure that the signal cable is attached firmly. 2. Check the video signal source to see if it is beyond the range of the display. Please verify its specifications with this display's specification section.

<p>Display image doesn't fill up the full size of the screen</p>	<ol style="list-style-type: none"> 1. The zoom mode is not set correctly. 2. Scan Mode may be set incorrectly to underscan. 3. If the image exceeds the screen size, Scan Mode may need to be set to Underscan. 	<p>Use the Zoom mode or Custom zoom function in the Screen menu to fine tune display geometry and time frequency parameter.</p>
<p>Can hear sound, but no picture</p>	<p>Source signal cable is connected improperly.</p>	<p>Make sure that both video inputs and sound inputs are correctly connected.</p>
<p>Can see picture but no sound is heard</p>	<ol style="list-style-type: none"> 1. Source signal cable is connected improperly. 2. Volume is turned all the way down. 3. {Mute} is turned on. 4. No external speaker connected. 	<ol style="list-style-type: none"> 1. Make sure that both video inputs and sound inputs are correctly connected. 2. Press [⊕] or [⊖] button to hear sound. 3. Switch MUTE off by using the [MUTE] button. 4. Connect external speakers and adjust the volume to a suitable level.
<p>Some picture elements do not light up</p>	<p>Some pixels of the display are off.</p>	<p>This display is manufactured using an extremely high level of precision technology: however, sometimes some pixels of the display may not display. This is not a malfunction.</p>

After-Images can still be seen on the display after the display is powered off. (Examples of still pictures include logos, video games, computer images, and images displayed in 4:3 normal mode)

A still picture is displayed for an over extended period of time

Do not allow a still image to be displayed for an extended period of time as this can cause a permanent after-image to remain on the display.

5. Technical Specifications

5.1 Display:

Item	Specifications		
	DS-D6065UN	DS-D6075UN	DS-D6086UN
Screen Size (Active Area)	1428.48(H) x 803.52(V)[mm]	1649.664(H) x 927.936(V)[mm]	1895.04(H) x 1065.96(V)[mm]
Aspect Ratio	16:9	16:9	16:9
Number of pixels	3840 (H) x 2160 (V)	3840 (H) x 2160 (V)	3840 (H) x 2160 (V)
Pixel pitch	0.372 (H) x 0.372 (V) [mm]	0.4296 (H) x 0.4296 (V) [mm]	0.4935 (H) x 0.4935 (V) [mm]
Displayable colors	8 bits+FRC, 1.07 Billion colors	8 bits+FRC, 1.07 Billion colors	8 bits+FRC, 1.07 Billion colors
Brightness (typical)	500 cd/m2(typical), 400 cd/m2(min)	500 cd/m2(typical), 400 cd/m2(min)	500 cd/m2(typical), 400 cd/m2(min)
Contrast ratio (typical)	1200:1	1200:1	1200:1
Viewing angle	178 degrees	178 degrees	178 degrees

In/Out Terminals:

Item		Specifications
Speaker Output	Internal Speakers	10W (L) + 10W (R) [RMS]/8Ω 82 dB/W/M/160 Hz - 13 KHz
Audio Output	3.5mm phone jack x 1	0.5V [rms] (Normal) / 2 Channel (L+R)
Audio Input	3.5mm phone jack x 1	0.5V [rms] (Normal) / 2 Channel (L+R)
RS232	2.5mm Phone jack x 2	RS232 in/RS232 out
RJ-45	RJ-45 Jack x 1 (8 pin)	10/100 LAN Port
HDMI Input	HDMI Jack x 2 (Type A) (19 pin) (HDMI in x 2)	Digital RGB: TMDS (Video + Audio) MAX: Video - 720p, 1080p, 3840 x 2160/60 Hz Audio - 48 KHz/ 2 Channel (L+R) Supports LPCM only

DP Input /Output	DP Jack x 2	Digital RGB: TMDS (Video + Audio) MAX: Video - 720p, 1080p, 3840 x 2160/60 Hz Audio - 48 KHz/ 2 Channel (L+R)
DVI-I Input	DVI-I Jack	Digital RGB: TMDS (Video) MAX: 1920 x 1080/60 Hz (WUXGA)
IR Input/Output	3.5mm x 2	IR pass through
USB Input	USB x 2 (Type A)	USB 2.0, Multimedia play and service port

General:

Item	Specifications		
	DS-D6065UN	DS-D6075UN	DS-D6086UN
Power Input	100 - 240V VAC, 50/60Hz	100 - 240V VAC, 50/60Hz	100 - 240V VAC, 50/60Hz
Power Consumption (Max)	330 W	380 W	570 W
Power Consumption (typ.)	179 W	250 W	375 W
Power Consumption (Standby & Off)	<0.5 W	<0.5 W	<0.5 W
Dimensions [W x H x D]	1462.3 x 837.3 x 93.4 mm	1683.5 x 961.7 x 95.3 mm	1929.0 x 1100.0 x 95.3mm
Weight	27.8 Kg	37.5 Kg	49.5 Kg
Visible Screen Size	1639 mm / 64.5 inch	1893 mm / 75 inch	2174 mm / 86 inch
On Mode Power Consumption (W)	188 W	210 W	373 W
Annual Energy Consumption (kWh)	274 kWh	349 kWh	545 kWh
Standby Power Consumption (W)	0.5 W	0.5 W	0.5 W
Off Mode Power Consumption (W)	0.5 W	0.5 W	0.5 W
Display Resolution (Pixels)	3840 x 2160	3840 x 2160	3840 x 2160

Environmental Condition:

Item		Specifications
Temperature	Operational	0 - 40°C
	Storage	-20 - 60°C
Humidity	Operational	20 - 80% RH (No condensation)
	Storage	10 - 90% RH (No condensation)
Altitude	Operational	0 - 3,000 m
	Storage / Shipment	0 - 9,000 m

5.2 Input Mode

Timing Support:

Item	Resolution	H.Freq. (KHz)	V.Freq. (Hz)
1	720×400 @70Hz DOS	31.469	70.087
2	640×480 @60Hz DMT	31.469	59.94
3	640×480 @67Hz MAC	35	66.667
4	640×480 @75Hz DMT	37.5	75
5	800×600 @60Hz DMT	37.879	60.317
6	832×624 @75Hz MAC	49.725	74.5
7	1024×768 @60Hz DMT	48.363	60.004
8	1152×870 @75Hz MAC	68.681	75.062
9	1280×720 @60Hz CVT16:9	44.772	59.855
10	1440×900 @60Hz CVT16:10 R	55.469	59.901
11	1440×900 @60Hz CVT16:10	55.935	59.887
12	1680×1050 @60Hz CVT16:9 R	64.674	59.883
13	1680×1050 @60Hz CVT16:9	65.29	59.954
14	1920×1080 @60Hz CVT-RB / XBOX360	66.7	60
15	1920×1080 @60Hz DMT-RB	67.5	60
16	480i@60Hz	15.734	59.94
17	480P@60Hz	31.469	59.94
18	720P@60Hz	44.955	59.94
19	1080I@60Hz	33.716	59.94
20	1080P@60Hz	67.433	59.94
21	576i@50Hz	15.625	50
22	576P@50Hz	31.25	50
23	720P@50Hz	37.5	50
24	1080I@50Hz	28.125	50.08
25	1080P@50Hz	56.25	50
26	3840x2160@30	67.5	30
27	3840x2160@60	135	60

- The PC text quality is optimum in UHD mode (3840 x 2160, 60Hz).
- Your PC display screen might appear different depending on the manufacturer (and your particular version of Windows).
- Check your PC instruction book for information about connecting your PC to a display.

- If a vertical and horizontal frequency-select mode exists, select 60Hz (vertical) and 31.5KHz (horizontal). In some cases, abnormal signals (such as stripes) might appear on the screen when the PC power is turned off (or if the PC is disconnected). If so, press the [INPUT] button to enter the video mode. Also, make sure that the PC is connected.
- When horizontal synchronous signals seem irregular in RGB mode, check PC power saving mode or cable connections.
- The display settings table complies to the IBM/VESA standards, and based on the analog input.
- The DVI support mode is regarded as same to the PC support mode.
- The best timing for the vertical frequency to each mode is 60Hz.



See Far, Go Further